

hudson

Coatstand

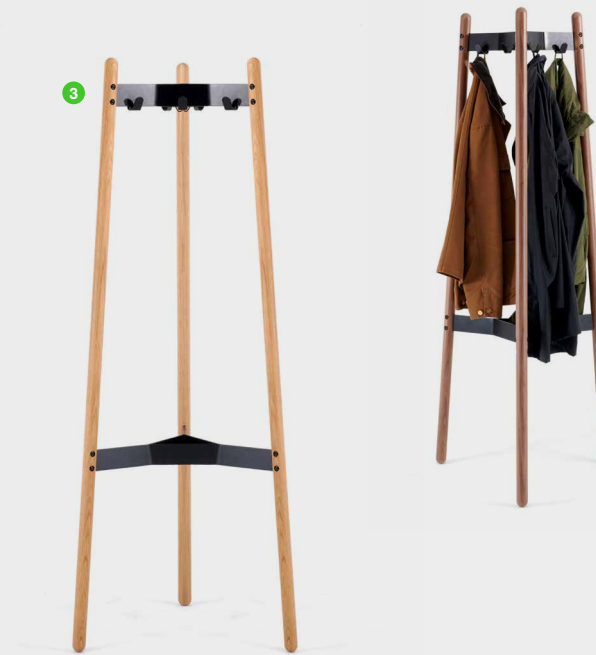
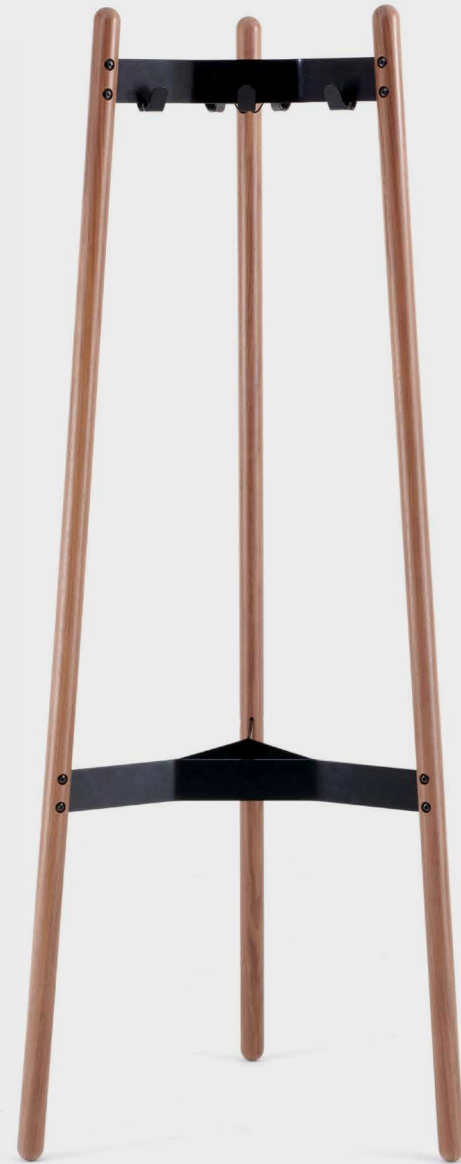

About Hudson

Hudson is named after the iconic housekeeper of 221B Baker Street. As the keeper of the coats, Hudson maintains its presence in the room even when filled with coats.

Functional and beautiful, the Hudson coat stand has a residential appeal that perfectly complements other products in the naughtone range that feature oak, walnut or folded steel.

Compliance

- naughtone is FISP and ISO14001 certified

Size

All dimensions quoted are rounded to the nearest 5mm or nearest 1/2 inch

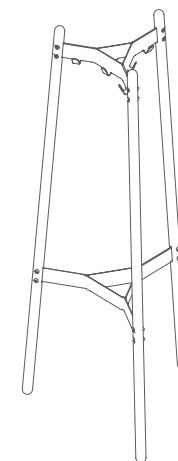

NOHUD
Hudson Coatstand
mm
W640 D560 H1620
inch
W25 D22 H63.5

Finishes

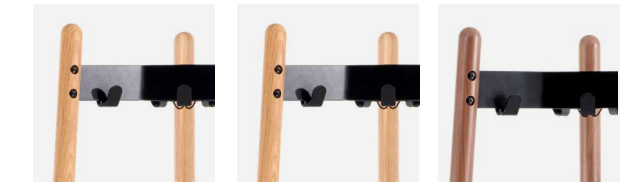

Black / White
Powder Coated Steel Frame
Standard

Oak Legs
Standard

Walnut Legs







Hudson Coatstand Technical Specifications

Servicing

If a component is damaged and needs replacing then please email our team with an image of the damaged part and reference your order number, we will be happy to facilitate any replacements.



Warranty

naughtone offers a **7 Year** warranty across all products. Details on the terms and conditions of naughtones warranty can be found at naughtone.com/warranty



Hudson Coatstand Technical Specifications

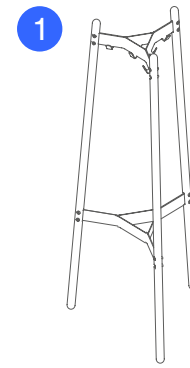

Product Code and Description <small>All dimensions quoted are rounded to the nearest 5mm or nearest 1/2 inch</small>	A Width	B Depth	C Height	G Weight
1 NOHUD Hudson Coatstand	640 mm 25 in	560 mm 22 in	1620 mm 63.5 in	7.8 kg 17.2 lbs

Measuring Guide

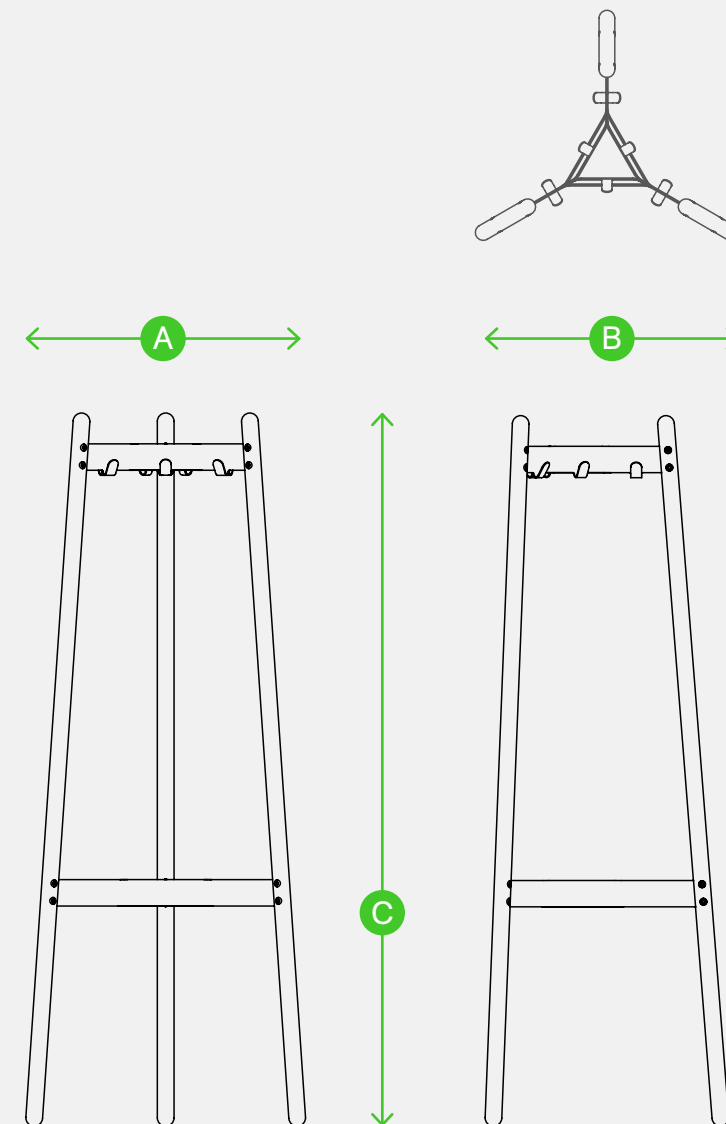

Hudson Coatstand Environmental Product Summary



Environment Attributes

- naughtone is **FISP** and **ISO14001** certified
- **7.8kg** total weight
- **51.6% Recyclable** (frame)
- **21.5% Recycled Content** (frame)

These attributes can help you to achieve criteria towards **LEED, BREEAM, Ska** and **WELL** building certifications



Hudson Coatstand Environmental Product Summary

Material Percentage Split

- 48.89% Mild Steel
- 48.41% Solid Oak
- 2.70% Mild Steel Zinc Plated

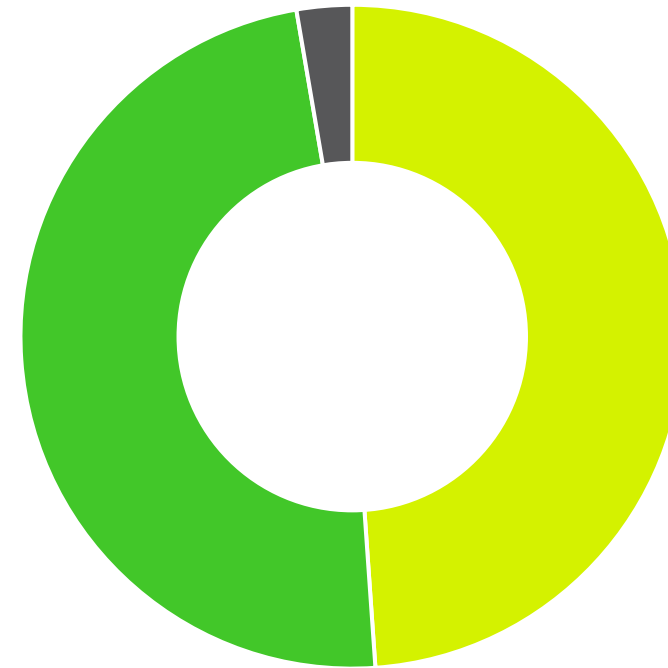

Post Consumer Recycled Content

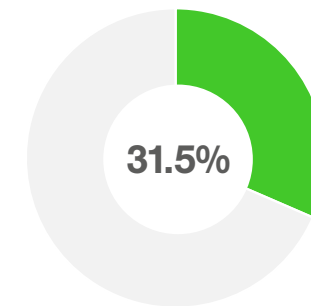

Recyclable Content

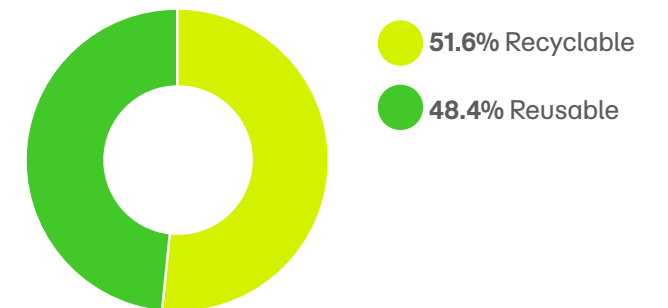

Product Specific Design Statement

The Hudson coat stand is a simple construction of dowel legs held together with folded steel rails that are finished with a hard wearing polyester powdercoat.

CSR Statement

naughtone has always considered the environment throughout our design and manufacturing process. We understand that as we continue to grow, so does our potential impact on our surroundings.

The addition of our North American manufacturing provision also helps to keep manufacturing miles to a minimum, as our market continues to grow in the USA. Finally, naughtone offers a 'bring back' programme, where the client is able to return the product to our factory, where we will be happy to breakdown and recycle the parts for you.

Where sustainable sources are quoted, and a chain of custody is required by a customer this must be indicated on the purchase order to naughtone. A chain of custody requested after an order has been placed or delivered may be difficult to recover. Figures stated in the Environmental product summary may vary based on model and options selected, we have based this document on a specific example when produced in the United Kingdom. Recycled content calculations are taken from supplier information and industry averages, material variables are likely to affect the figures which may result in higher or lower percentages. This document will be reviewed and updated periodically and is subject to change without notice.



1 Design

Every aspect of the naughtone product ranges has been designed with the environment considered, from ethical material choice and production efficacy to storage efficiency and ease of disassembly.

Dense foam sets and resilient fabrics are selected for their longevity and effectiveness across sectors. Durable high quality finishes such as powder coated bases in a range of colours allow clients the freedom of finish options. Finish samples are available allowing clients to make informed decisions and retain to add to their finish libraries for future reference.

2 Raw Material

Local supply of raw materials is employed for the production of our products when possible, procured from suppliers that are quality inspected for extraction methods and meet the highest environmental standards.

3 Production

As many of our products are assembled by hand the energy expenditure wasted from machinery during the production process is kept to a minimum.

All fabrics are cut to ensure optimum efficiency with fabric usage and reduced waste consumption per unit.

All production sites have recycling facilities for any excess product that cannot be used elsewhere, which is then managed by a professional third party.

4 Distribution

Distribution of naughtone products generally occurs directly between the manufacturing site to the client. Production is localised when possible to the US or UK regions, reducing the carbon footprint and miles travelled for each product.

Many items are flat packed for delivery or shipped disassembled with efficient, minimised packaging; optimizing the transportation vessel space.

5 Usage

naughtone products do not require energy or water to function, thus no environmental exchange takes place and no waste is generated during the life of the product.

The only foreseeable need is the cleaning of the product for general maintenance. This includes regular vacuuming to remove dirt and dust particles on upholstery items, and using a dry or damp cloth to wipe non-upholstery items.

This is recommended for all products utilised under conditions of normal wear and is expected to have negligible environmental impacts.

6 End of Life

Although our products are durable and demonstrate timeless design, naughtone products are manufactured in such a way that they can be easily disassembled at the end of life and most of the componentry can be either recycled or re-used as applicable.

As a company we are also happy to accept the return of products, to help re-home or recycle furniture or components at the end of the products useful life.

UK Showroom

6 Bakers Yard
Clerkenwell
London EC1R3DD
T: +44 (0)20 389 22 788

US Showroom

Suite 11-88
222 Merchandise Mart Plaza
Floor 11
Chicago IL 60654

naughtone HQ

Knaresborough Tech Park
Manse Lane
Knaresborough HG5 8LF

T: +44 (0) 1423 816 500
E: sales@naughtone.com

www.naughtone.com